

Blue Laser Diode

Part No: LD-450-80-70-E-9

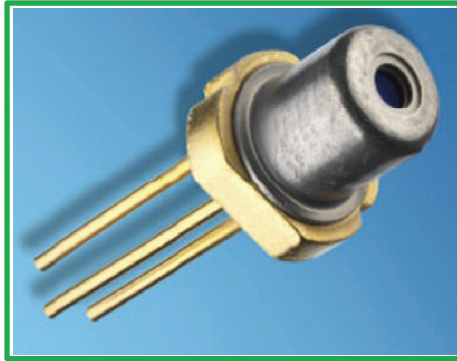

Features

- ※ Short wavelength: $\lambda=450\text{nm}$ (Type)
- ※ Operating mode: CW & Pulse
- ※ Transverse mode: Single
- ※ Package: T0-38 ($\Phi 3.8\text{mm}$)
- ※ High modulation bandwidth

Applications

- ※ Laser projection
- ※ Instrumentation
- ※ Holography
- ※ Metrology
- ※ Biomedical Applications

Absolute Maximum Rating at $T_c=25^\circ\text{C}$

Items	Symbols	Values	Unit
Optical Output Power	P_o	50	mW
Laser Diode Reverse Voltage	V	2	V
Operating Temperature	T_{opr}	$+10\sim+70$	$^\circ\text{C}$
Storage Temperature	T_{stg}	$-40\sim+85$	$^\circ\text{C}$

Electrical and Optical Characteristics at $T_c=25^\circ\text{C}$

Items	Symbols	Min	Type	Max.	Unit	Condition
Optical Output Power	P_o	-	50	80	mW	CW
Threshold Current	I_{th}	-	30	60	mA	CW
Operating Current	I_{op}	-	80	120	mA	$P_o=50\text{mW}$
Slope Efficiency	SE	0.8	1.3	-	mW/mA	$P_o=50\text{mW}$
Operating Voltage	V_{op}	-	5.5	6.5	V	$P_o=50\text{mW}$
Lasing Wavelength	λ	440	450	460	nm	$P_o=50\text{mW}$
Spectral Width(FWHM)	$\Delta\lambda$	-	2	-	nm	$P_o=50\text{mW}$
Beam Divergence	//	4	7	15	$^\circ$	$P_o=50\text{mW}$
	\perp	15	21	25	$^\circ$	$P_o=50\text{mW}$
Beam Angle	$\Delta//$	-	-	± 2	$^\circ$	$P_o=50\text{mW}$
	$\Delta\perp$	-	-	± 3	$^\circ$	$P_o=50\text{mW}$
Modulation Frequency	F	-	>100	-	MHz	$P_o=50\text{mW}$

Blue Laser Diode

Optical Output Power

$$P_o = f(I_{op})$$

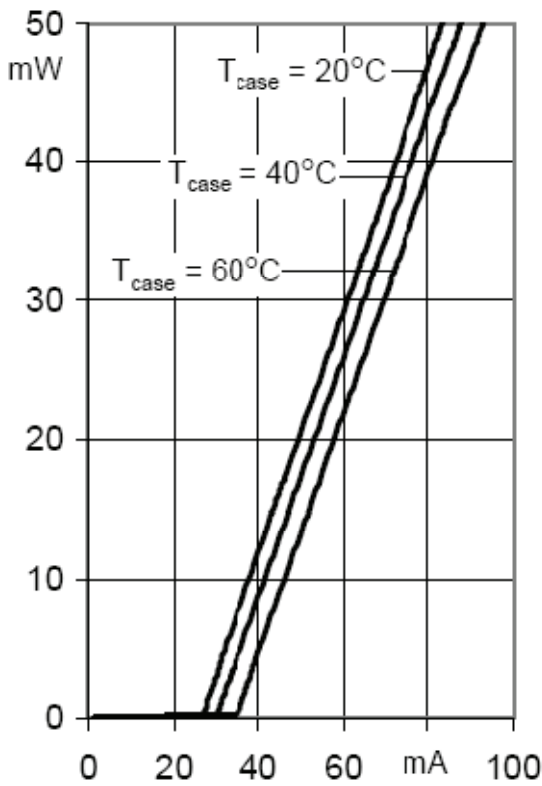

Operating voltage

$$V_{op} = f(I_{op})$$

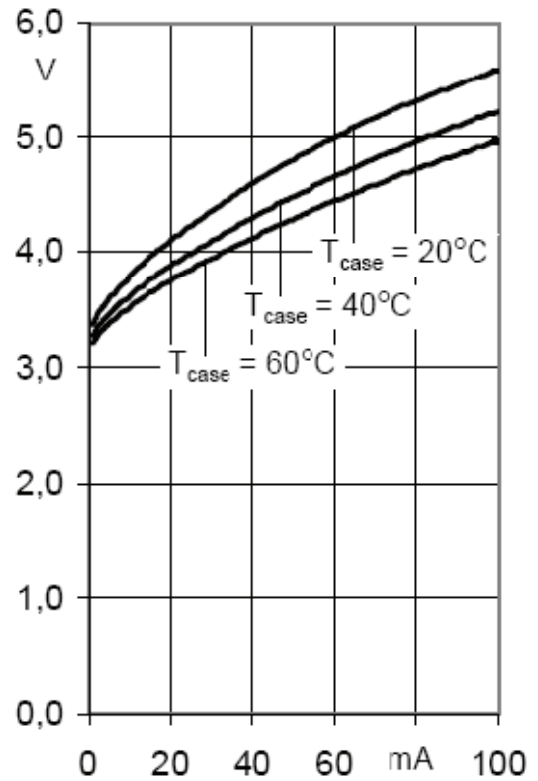

Threshold Current

$$I_{th} = f(T_{case})$$

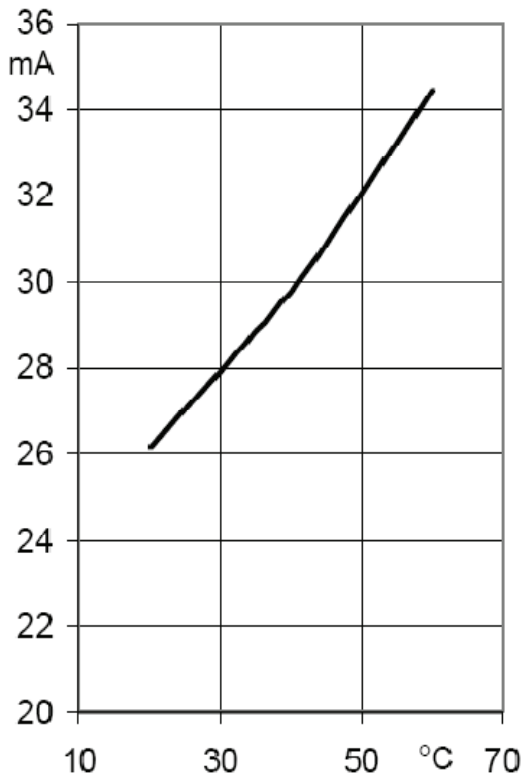

Emission Wavelength

$$\lambda = f(T_{case})$$

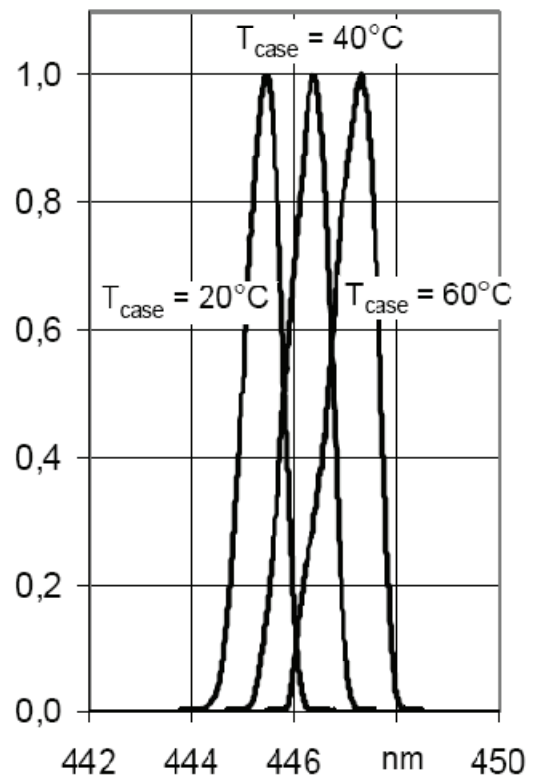

Blue Laser Diode

Beam Angle

$T_{\text{case}}=25^{\circ}\text{C}$

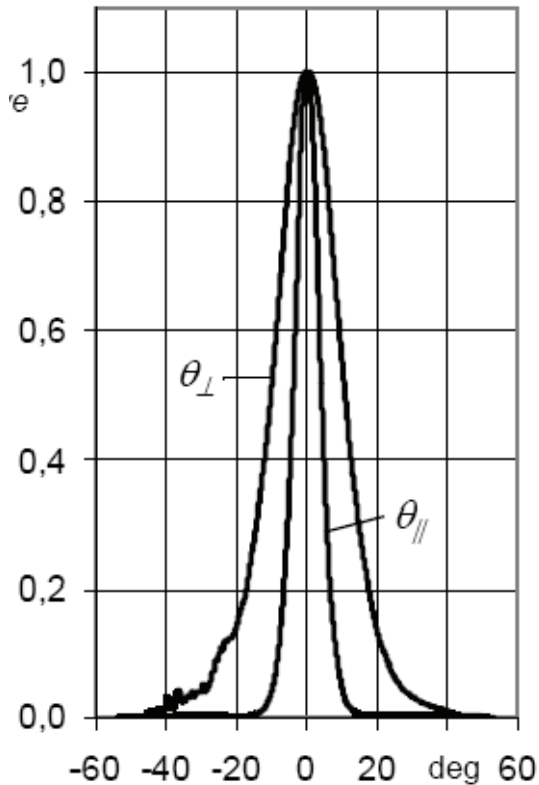

Notes

- 1) Operation above the maximum conditions can damage the laser diode or reduce its lifetime.
- 2) The laser diode is very sensitive to electrostatic discharge (ESD). Proper precautions must be taken.
- 3) In order to maintain the lifetime of the laser diode proper heat management is essential.
- 4) These devices emit highly concentrated visible light which can be hazardous to the human eye.

Blue Laser Diode

Package and Electrical connection

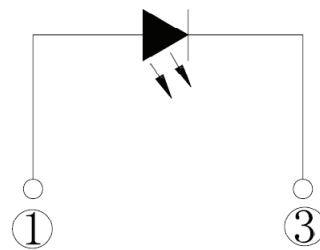
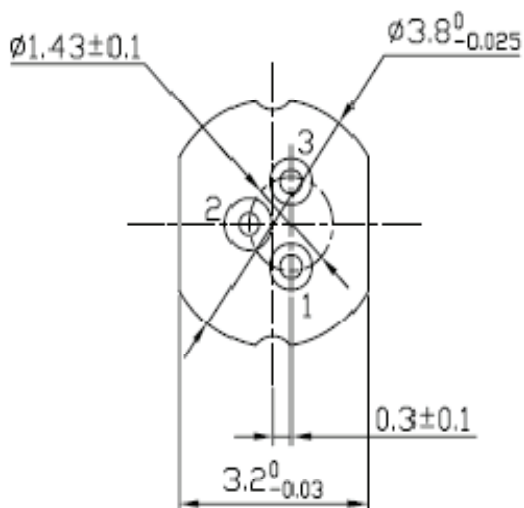
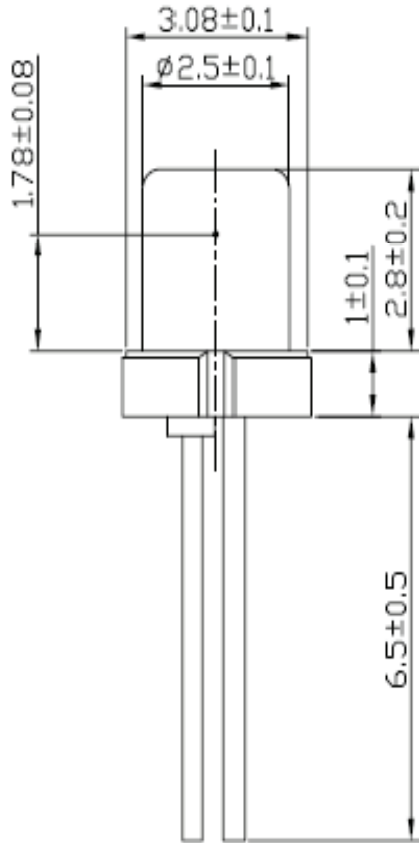

E-type